



Under Development	●
Mass production	

RoHS

# Specification

Client Name :

客户名称 : \_\_\_\_\_

Client P/N :

客户品号 : \_\_\_\_\_

Product P/N :

产品型号 : HL-LE003F9VW-20B1C46 (Ra2)

Sending Date:

送样日期 : \_\_\_\_\_

Client approval 客户审核		Hongli approval 鸿利光电审核		
Approval 核准	Audit 确认	Approval 核准	Audit 确认	Confirmation 制作
				尹键
<input type="checkbox"/> Qualified 接受		<input type="checkbox"/> Disqualified 不接受		DATE: 日期 : 2016.03.15

Adr : Xianke 1st Rd, Huadong Town, Huadu Dist., Guangzhou, China

地址 : 广州市花都区花东镇先科一路1号

Tel/电话 : 020-86733333

Fax/传真 : 020-86733883 86733938

Web/网址 : www.honglitronic.com

注:1. 此规格书以中英文方式书写,若有冲突以中文版本为准文本.

2. 此规格书的最终解释权归广州市鸿利光电股份有限公司

3. 此规格书的有效期限为两年,自盖章或签字之日起计算,期满时双方可以续签协议,但应采用书面形式

Copyright©2016 Guangzhou Hongli Opto-Electronic Co., Ltd. All rights reserved.



Under Development	●
Mass production	

## 1、Part code 产品型号命名原则

LE 003 F9V W -X BXCX (Ra2)

① ② ③ ④ ⑤ ⑥ ⑦



- |                              |        |
|------------------------------|--------|
| ① Product line               | 产品系列代码 |
| ② Product code base plate    | 产品基板代码 |
| ③ Chip code                  | 芯片代码   |
| ④ Emitting light colors      | 发光颜色代码 |
| ⑤ Power                      | 功率代码   |
| ⑥ Serial/Parallel connection | 电路组合代码 |
| ⑦ CRI                        | 显色指数代码 |

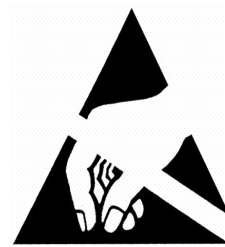

**ATTENTION注意**  
OBSERVE PRECAUTIONS  
FOR HANDLING  
ELECTROSTATIC  
DISCHARGE  
SENSITIVE  
DEVICES  
请勿裸手接触器件

## 2.Features 特点

- Dimension :40.0mm×40.0mm×3.5mm 尺寸：40.0mm×40.0mm×3.5mm
- Combination of COB and AC technology COB和AC技术的组合
- Long lifetime 寿命长
- PF>0.95 THD<20% 功率因素>0.95 谐波<20%
- Compatible with TRIAC dimmers 兼容可控硅调光器
- Easy assembly 组装方便
- RoHS compliant 符合RoHS标准

## 3.Applications 应用

indoor lighting 室内照明

- Spot Light 射灯
- Bulb 球泡灯
- Down lighting 筒灯



Under Development	●
Mass production	

#### 4.Package Dimensions 封装尺寸

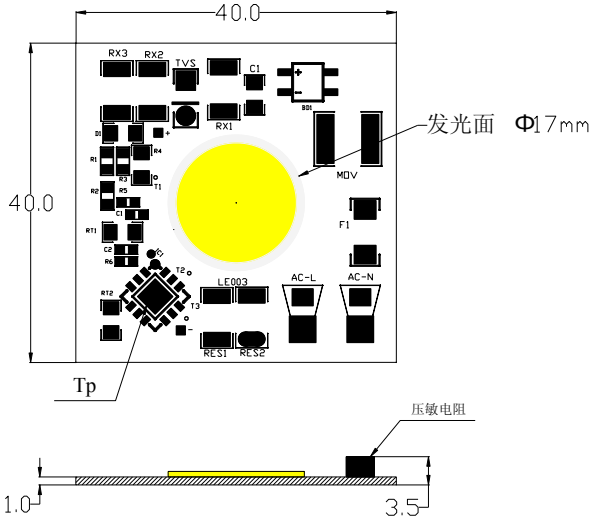

Tolerance unless otherwise specified: ±0.3mm.

尺寸公差为±0.3毫米除非另有说明

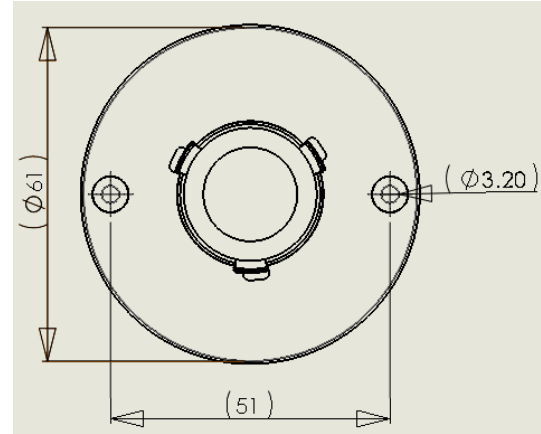

The products supporting PC snaps.

该产品配套PC卡扣

#### 5.Performance 性能

##### (1) Absolute Maximum Ratings

Parameter 参数	Symbol 符号	Rating Value 值	Units 单位
Maximum Voltage 最大电压	$V_{OPT}$	250	V [RMS]
Power Dissipation 耗散功率	$P_D$	22	W
Junction Temperature 结温 *(1)	$T_j - LED$	120	°C
	$T_j - IC$	125	°C
Top of the IC temperature IC顶部温度	$T_p$	100°C	
Operating Temperature Range 工作温度	$T_{op}$	-35° C To +85° C	
Storage Temperature Range 储藏温度	$T_{stg}$	-40° C To +100° C	
ESD Sensitivity 静电测试	ESD	±2,000V HBM	
Lead Soldering Temperature*引线焊接温度	$T_{sol}$	Max. 350°C for 5sec Max.	

##### Notes for Table

(1) The capacity of heat sink :  $T_{j-ic} < 125^\circ C$

$$T_{j-ic} = T_p + P_{ic} * R_{ic} \quad (P_{ic} = 2.5W \quad R_{ic} = 9^\circ C/W \quad T_p : \text{surface temperature of IC})$$

散热器散热能力 :  $T_{j-ic} < 125^\circ C$  为要求

$$T_{j-ic} = T_p + P_{ic} * R_{ic} \quad \text{其中 } P_{ic} = 2.5W \quad R_{ic} = 9^\circ C/W \quad T_p = \text{IC表面温度}$$

(2) All extreme conditions need to be satisfied.

所有极限条件需同时满足。



**(2) Electro-Optical Characteristics**

**at Tc=25°C**

光电特性 Tc=25°C

Parameter参数	Symbol符号	Condition 条件	Min.	Typ.	Max.	Unit 单位
Operating Voltage 工作电压 *(1)	V <sub>OPT</sub>	—	200	230	250	V
Power Dissipation 功率	P <sub>D</sub>	V <sub>OPT</sub> =230V/50HZ	18.5	19.5	20.5	W
Luminous Flux 光通量	Φ <sub>v</sub>	TC=3000K	1800	1950	2150	lm
		TC=5700K	1840	2000	2200	
CRI 显色指数	Ra	V <sub>OPT</sub> =230V/50HZ	80	—	—	—
Power Factor	PF	V <sub>OPT</sub> =230V/50HZ	0.95	—	—	—
Tolerance of Surge 浪涌*(7)	V <sub>s</sub>	—	500	—	—	V

**Notes for Table**

1. Operating Voltage doesn't indicate the maximum voltage which customers use but means tolerable voltage according to each country's voltage variation rate.

客户不能在最大电压下正常使用，最大电压定义为不同国家的电压波动情况。

2. Color bins are defined at transient operation

该产品通过瞬态点亮测试，分光分色。

3. The tolerance of measurement at our tester is Φ<sub>v</sub>+/-10% and Ra+/-2.

测试仪测量的公差 流明±10% 和显指±2。

4. Tolerance of ±0.005 on x,y coordinates.

色坐标的测量误差允许在±0.005。

5. Tolerance of ±5% on Power dissipation.

功率的测试误差允许在±5%

6. Φ<sub>v</sub> is the total luminous flux output measured with an integrated sphere.

总光通量在积分球内测量。

7. Surge is defined as damage that may occur when an electronic device is subjected to a voltage that is beyond the maximum specification limits of the device.

Refer to the note 3 .

当启动电压干扰尖峰超过最大电压时，会对模组造成损坏。

参考注意事项3。

8. Base Board: 1.0mm ceramic substrate, Thermal resistance 20 W/(m.K)

基板材质: 1.0mm厚度陶瓷基板，导热系数20 W/(m.K)



Under Development	●
Mass production	

## 6.Characteristics特性

### 6.1 Color spectrum

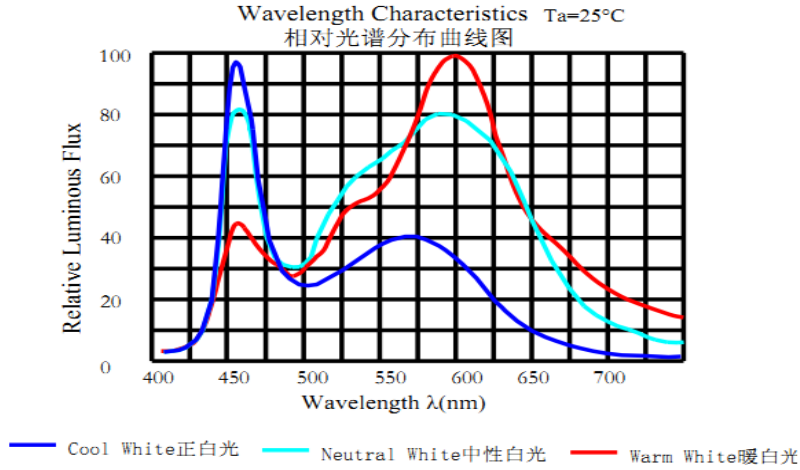

### 6.2 Relative Power Distribution vs. Voltage at Ta=25°C

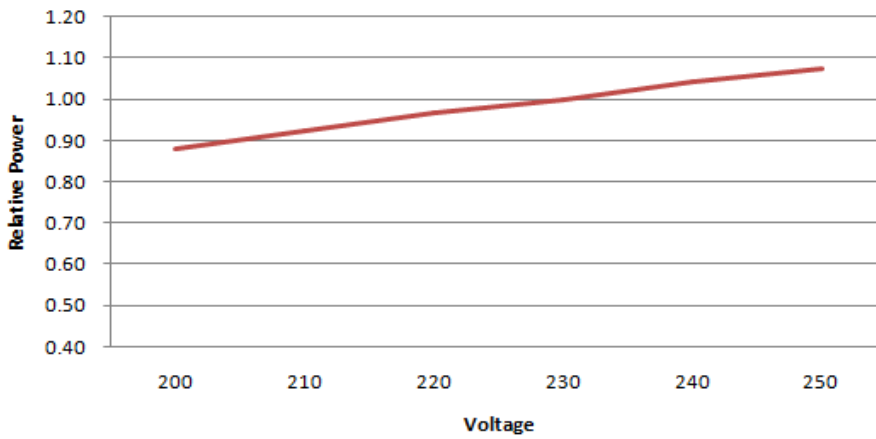

### 6.3 Relative Luminous flux vs. Voltage at Ta=25°C

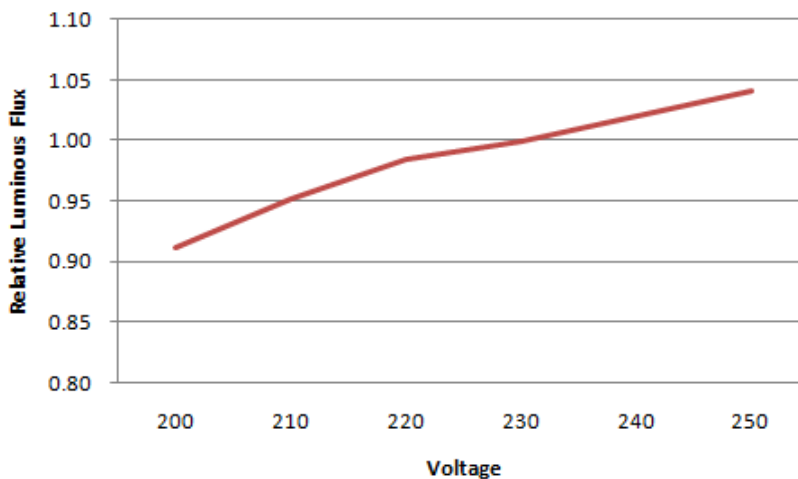



Under Development	●
Mass production	

## 7.Product bins 产品分级

**Chromaticity bins**

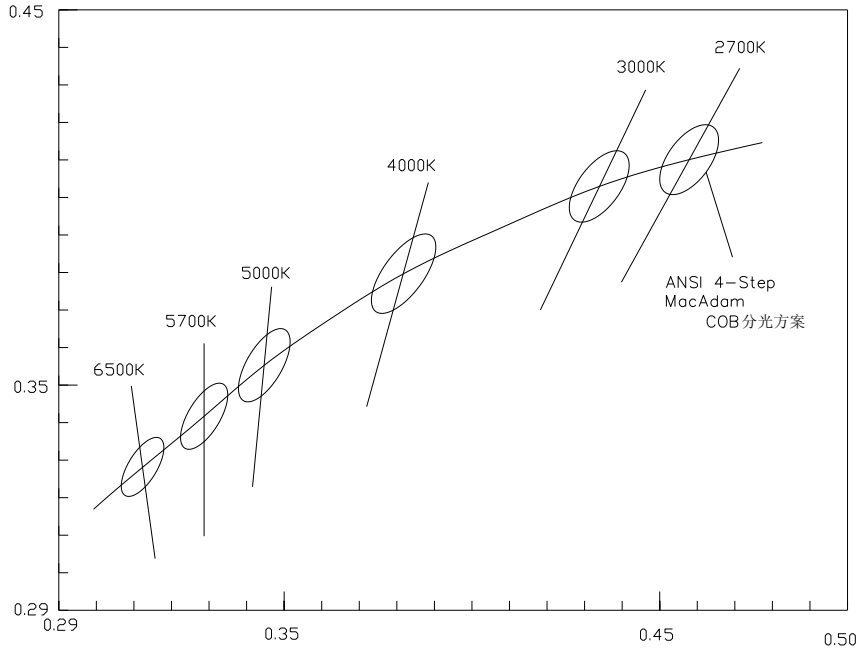

Center TC	2725K	3045K	3985K	5028K	5665K	6530K
X,Y	0.4578,0.4101	0.4338,0.403	0.3818,0.3797	0.3447,0.3553	0.329,0.3417	0.3123,0.3282

Notes :

- 1、 The chromaticity center refers to ANSI C78.377-2008  
色温分bin参考ANSI C78.377-2008



Under Development	●
Mass production	

### 8.Packing Specifications 包装规格

	HONGLITRONIC 鸿利光电	
TYPE:		QTY:
VF:		φV:
TC:	X/Y:	
SDCM<	Ra:	
DATE:		LOT.NO:

Label on blister packaging 吸塑盒标签

	HONGLITRONIC 鸿利光电	成品标示卡 (Product Identity Card)
品名(Description):	High Power LEDs	
产品型号(Type):	XXXXXXXX XXXXXXXX	
发光颜色(Color):	XXXXXX	
数量(QTY):	XXXXK	
生产批号(LOT NO):	XXXXXXXX XXXXXXXX	
出货日期(Date):	XXXX.XX.XX	
操作员(Operator):	XXXX	

Label on box 外箱标签

φV: Luminous Flux rank 光通量档次典型值

TC: Color temperature 色温

#### ■ Packing figure 包装图

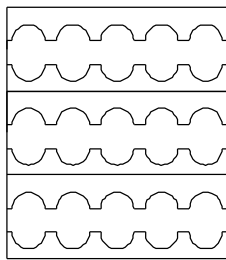

Tray: 15pcs

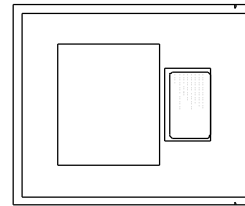
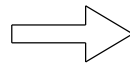

2Tray/ESD Shilding Bag: 30p cs

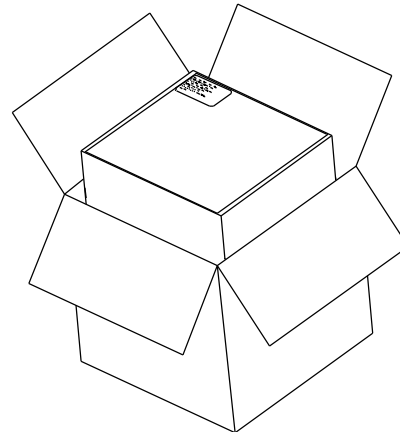

3ESD Shilding Bag/Inner Box: 90pcs

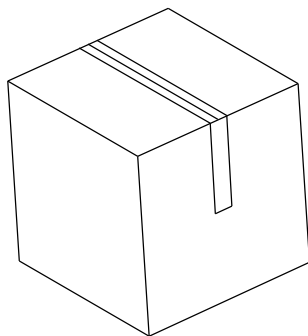
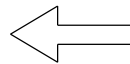

4Inner Box/Outer Box:360pcs





Under Development	●
Mass production	

## Precautions (注意事项)

### 1. Storage 储存

■ To avoid moisture, we recommend storage conditions for the unopened LED +5 ~ +30 ° C, relative humidity <60%. LED should be used within 168 Hrs. of opening the package. Please make sure to dehumidify and vacuum pack the remaining/unused LED. Dehumidifying condition: +120 ° C ± 5 ° C, 04 Hrs. Effective age for the sealed led is one year.

为避免受潮的影响，我司建议产品在未开包装前储存条件为 5-30° C，相对湿度小于 60%。已开包装的 LED 光源请在 168H 内使用安装完毕，如未用完之产品，请进行除湿并抽真空后密封保存。除湿条件：120° C±5° C，4H。产品密封保存有效使用期为一年。

### 2. The soldering precautions 组装注意事项

■ During assembly, please ensure that a good quality thermal paste is applied and distributed evenly over the surface. While using thermal pad (Heat Sink), make sure LED is firmly tightened and there is no gap between surfaces.

为确保在组装时降低接触热阻，请注意导热膏涂布均匀且分布面积合理，不可出现导热膏太少或涂抹高低不平等现象。如使用导热胶垫时，请确保螺丝安装后基板与导热胶垫的完全接触，不可存在中空现象。

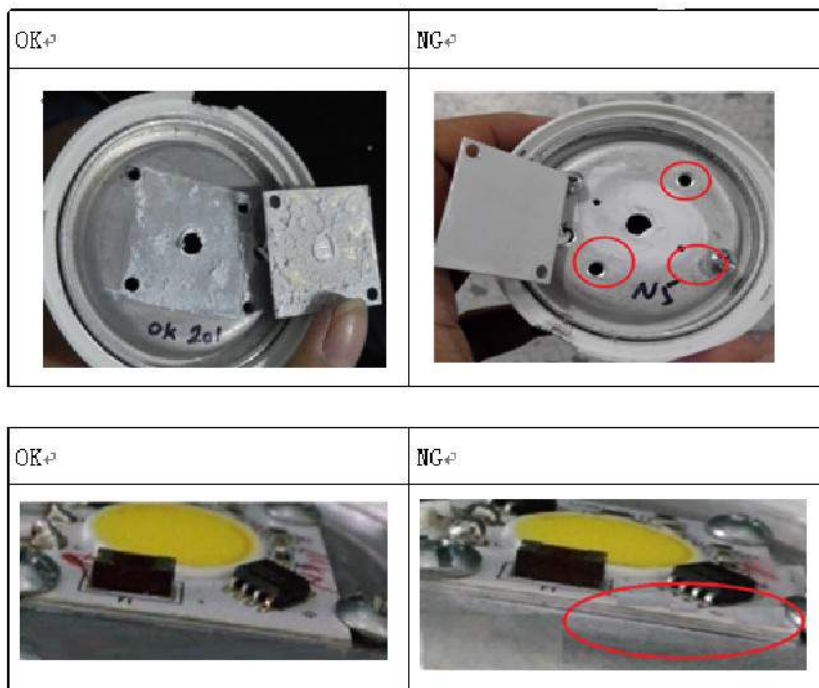





Under Development	●
Mass production	

- Please make sure of not getting short during the welding process.  
焊接完毕后，请确保无短路现象，以免烧毁器件。

Due to connecting high voltage, pay attention to safety when installing and/or testing.

由于该产品接高压，因此在该产品安装调试时请务必注意安全。

Do not touch the module without any reasonable ESD protection while circuit is active.

当电源工作时，不要触碰模组任何地方，如PCB板，器件等。

Hot-plug test is not recommended.

不建议做热插拔测试。

### 3、Cautions for use 使用注意事项

- The module is recommended to apply in indoor lighting, Before using altered specifications

other than recommended, please consider risk factors.

本产品使用于室内照明，其它使用环境请自行风险评估。

- Faults, lightning, or switching transients can cause voltage surges in excess of the normal ratings.

故障，闪电或者开关短路可能引起电压瞬态升高，超过额定值。

- Internal component failure can cause excessive voltages.

内部元器件失效有可能导致电压超高。

- Electrical Over-Stress (EOS) is defined as damage that may occur when an electronic device is subjected to a current or voltage that is beyond the maximum specification limits of the device.

EOS损坏发生在电流或电压超过最大限制。



Under Development	●
Mass production	

4、Anti-Static Measures防静电措施:

- Please take adequate measures to prevent electrostatic generation, such as wearing electrostatic ring or anti-static fingerstall etc; any relative products like plant equipment, machinery, carrier and transportation units shall be connected to discharging unit/ ground. The ESD sensitivity of this product is > 1000V, after assembly the final lamp, please make sure to discharge Static Electricity by proper ESD equipment.

请采取足够的措施来防止静电产生，比如带静电环或防静电手指套等；每个制造厂关于产品（工厂、设备、机器、载波机和运输单位）应当连接到底面，请避免产品电气带电；本产品的防静电敏感度超过1000V，装配后的最终灯具产品（S）建议检查是否损坏LED（漏电现象）。

5. Temperature Control温度控制:

- Recommended temperature conditions for enhanced product life: Be sure to Tp point (The top of IC) controlled below 100 °C; COB recommendation colloid surface temperature control ≤200 °C.

保证散热前提条件为：请务必将Tp点（IC顶部）控制在100°C以下；建议COB胶体表面温度控制≤200°C。

6. Other其他:

- Product is not suitable to use in following conditions

本产品不可在以下条件下使用，如果产品在以下条件下使用，评估其使用效果和风险是有必要的：

Touch the silicone resin area with sharp objects such as pincett (tweezers).

用尖物（如镊子）去碰硅树脂区域。

Excessive force more than 3000gf on the silicone lens.

胶体上按压大于等于3000gf的力。

Cover the silicone resin area with any other resins such as epoxy, urthane, etc

用其它树脂材料，如环氧树脂、聚氨酯等覆盖在硅树脂区域。

Assemble/use in conditions of high moisture and/or strong oxidizing gas such as

Cl, H<sub>2</sub>S, NH<sub>3</sub>, SO<sub>2</sub>, NO<sub>x</sub>, etc.

在高湿或者强氧化气体，如Cl, H<sub>2</sub>S, NH<sub>3</sub>, SO<sub>2</sub>, NO<sub>x</sub>的环境下使用。

Use with substance containing sulfur.

与含硫元素物质一起使用。

Long time exposure to sunlight or UV can cause silicone discolored.

长时间暴露在太阳或UV底下，会使胶发生变色。

Exposed to dust, liquids or oils.

被暴露于粉尘、液体或油。